



OPTO ENGINEERING

ILLUMINATOR DATA

LTZPFL160-00-3-RGB-24V

Lighting Dimension

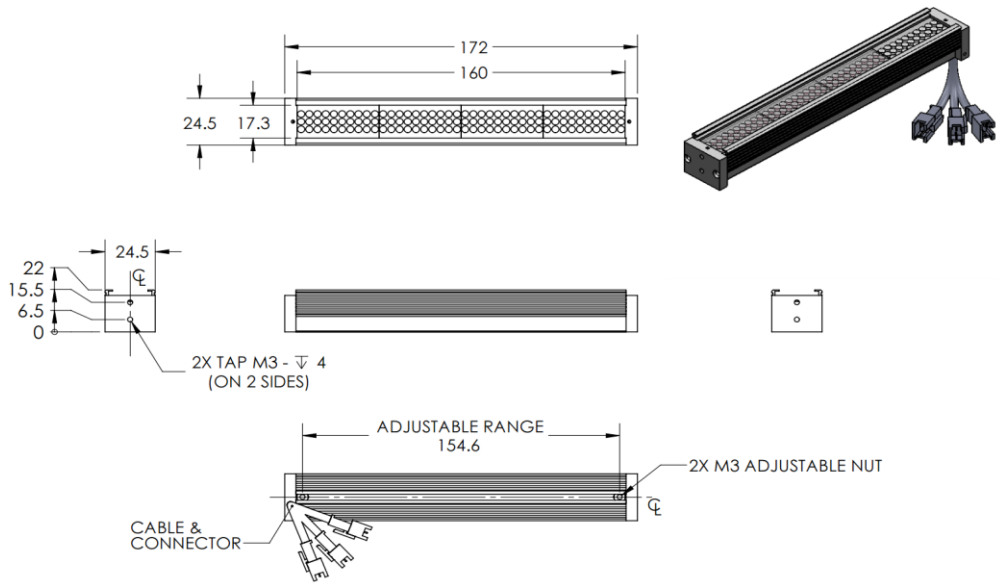

Mechanical Information

Casing Material	Aluminium
Storage Temperature Range	0 - 45°C
Storage Humidity Range	20 - 85%
Weight	115g
Length / Outer Diameter	172 mm
Width / Inner Diameter	24.5 mm
Thickness / Height	22 mm



OPTO ENGINEERING

ILLUMINATOR DATA

LTZPFL160-00-3-RGB-24V

Lighting Information									
Part Number	LBRX-00-160-3-RGB-24V								
LED Color	RED			GREEN			BLUE		
Wavelength	630 nm			525 nm			470 nm		
Working Distance	20 mm	30 mm	40 mm	20 mm	30 mm	40 mm	20 mm	30 mm	40 mm
Intensity (±15%)	16300 lx	11300 lx	8300 lx	26200 lx	18500 lx	13600 lx	32500 lx	22200 lx	16800 lx
Illumination (number of row)	3								
Illumination Active Area	Active Length / Outer Dia.			160 mm					
	Active Width / Inner Dia.			17.3 mm					
Emission angle	0								
Eye Safety Class (IEC62471)	EXEMPT			EXEMPT			II		
Chromaticity Table <i>For White colour only</i>	Nil								

Electrical Information			
Rated Constant Voltage	24V±2%		
Rated Constant Current	300 mA	300 mA	300 mA
Power Consumption	7.2 W	7.2 W	7.2 W
Casing temperature, After 60 minutes operation	63.5 °C		
Max. continous current of RED, GREEN & BLUE LEDs on at the same time	*It is not recommended to turn on Red, Green and Blue colour at the same time. Refer to Maximum Simultaneous Current Output section in the last page for maximum current that can be supplied for each colour. Failure in following this may results in damaging the lighting.		

Strobe Mode Specification			
*Normal Strobe Voltage	24 V		
*Normal Strobe Current	300 mA	300 mA	300 mA
Overdrive Voltage Range	Min: 36 V Max: 48 V	Min: 36 V Max: 48 V	Min: 36 V Max: 48 V
Overdrive Current Range	Min: 3 A Max: 3 A	Min: 2.2 A Max: 2.2 A	Min: 1.6 A Max: 1.6 A
Max. pulse current of RED, GREEN & BLUE LEDs on at the same time	*It is not recommended to turn on Red, Green and Blue colour at the same time. Refer to Maximum Simultaneous Current Output section in the last page for maximum current that can be supplied for each colour. Failure in following this may results in damaging the lighting.		
Recommended Overdrive Voltage	36V		
**Max. Trigger Pulse Duration	10 msec		
**Max. Duty Cycle	10%		

*Normal strobe means the lighting is operated using the rated power. Overdrive means the power supplied to the lighting exceeded the rated power.

***Overdrive condition must not exceed the max. trigger pulse duration and max. duty cycle. Failure in following this may results in damaging the lighting.

ILLUMINATOR DATA

LTZPFL160-00-3-RGB-24V

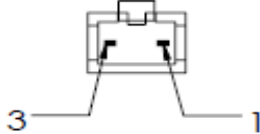
Connection Information			
Connector Type (Default)	JST SMR-03V		
Cable Length	50 cm		
Pin Configuration 	Pin	Signal	Cable Colour
	1	LED +	Red
	2	N.C	-
	3	LED -	White
			

Additional Information	
Additional Cooling Method	Attached to machine part for better heat dissipation
Intensity Controller Selection	SD, ST, ANG, LC, SDA, SDP series
CE Conformity	YES
RoHS Compliance	YES











Application	
Illumination Type	Direct Illumination
Application Use	Label Inspection, Character Inspection, Code Recognition



OPTO ENGINEERING

ILLUMINATOR DATA

LTZPFL160-00-3-RGB-24V

Maximum Simultaneous Current Output Information		
Colour	Current Limit (A)	Remarks
 SINGLE COLOUR : RED	0.5 A	TOTAL CURRENT OUTPUT : 0.5 A RECOMMENDED OVERDRIVE CURRENT : 1 A (36 V) ** OPTIMUM FOR SINGLE COLOUR
 SINGLE COLOUR : GREEN	0.4 A	TOTAL CURRENT OUTPUT : 0.4 A RECOMMENDED OVERDRIVE CURRENT : 1.17 A (36 V) ** OPTIMUM FOR SINGLE COLOUR
 SINGLE COLOUR : BLUE	0.45 A	TOTAL CURRENT OUTPUT : 0.45 A RECOMMENDED OVERDRIVE CURRENT : 1.21 A (36 V) ** OPTIMUM FOR SINGLE COLOUR
 COMBINE 2 COLOUR: RED & BLUE	0.5 A	TOTAL CURRENT OUTPUT : 0.5 A ****(EXAMPLE : RED = 0.25 A , BLUE = 0.25 A) ****(OVERDRIVE STROBE MODE EXAMPLE : RED = 0.5 A , BLUE = 0.5 A) FOR COMBINE COLOUR TEMPERATURE CANNOT EXCEED MORE THAN 60°C ENSURE CURRENT MUST NOT EXCEED 0.5 A 
 COMBINE 2 COLOUR: RED & GREEN	0.5 A	TOTAL CURRENT OUTPUT : 0.5 A ****(EXAMPLE : RED = 0.25 A , GREEN = 0.25 A) FOR COMBINE COLOUR TEMPERATURE CANNOT EXCEED MORE THAN 60°C ENSURE CURRENT MUST NOT EXCEED 0.5 A 
 COMBINE 2 COLOUR: GREEN & BLUE	0.5 A	TOTAL CURRENT OUTPUT : 0.5 A ****(EXAMPLE : GREEN = 0.25 A , BLUE = 0.25 A) ****(OVERDRIVE STROBE MODE EXAMPLE : RED = 0.5 A , BLUE = 0.5 A) FOR COMBINE COLOUR TEMPERATURE CANNOT EXCEED MORE THAN 60°C ENSURE CURRENT MUST NOT EXCEED 0.5 A 
 COMBINE COLOUR: RED, GREEN & BLUE	0.5 A	TOTAL CURRENT OUTPUT : 0.5 A ****(EXAMPLE : RED = 0.16 A , GREEN = 0.16 A , BLUE = 0.16 A) ****(OVERDRIVE STROBE MODE EXAMPLE : RED = 0.33 A , GREEN = 0.33 A , BLUE = 0.33 A) FOR COMBINE COLOUR TEMPERATURE CANNOT EXCEED MORE THAN 60°C ENSURE CURRENT MUST NOT EXCEED 0.5 A 



ILLUMINATOR DATA

LTZPFL160-00-3-RGB-24V

Lighting Pattern				
Working Distance	For further details please contact us.			
Display and Image				
Data Results	Horizontal	Meas.(mm)	Vertical	Meas.(mm)
	90%		90%	
	80%		80%	
	70%		70%	
	60%		60%	
	50%		50%	
	40%		40%	
	30%		30%	
	20%		20%	
	10%		10%	